

KEOFITT CLASSIC W25 SAMPLING VALVE

The KEOFITT CLASSIC W25 Sampling Valve is the largest KEOFITT sampling valve. Designed for sampling of very high viscosity products in the range of 0-250,000 cP and particles less than 17 mm in diameter.

This valve is used in a range of industries such as food, dairy, pharmaceutical and bio-tech for products such as:

- Peanut Butter
- Fruit Pulp
- Syrup
- Cellulose
- Fruit Mixed Products
- Cosmetics

Available with PTFE membrane.



KEOFITT CLASSIC W25 SAMPLING VALVE - BODIES

		WELDING BODIES	
		TANK WELDING	PIPE WELDING
W25 BODIES	1" CLAMP	 <p>870001</p>	<p><i>On request</i></p>
	VELDING LINER	<p><i>On request</i></p>	<p><i>On request</i></p>

		CONNECTION BODIES	
		VARIVENT Ø68	CLAMP
		 <p>870009</p>	<p><i>On request</i></p> <p>870003</p>
		<p><i>On request</i></p>	<p><i>On request</i></p>

KEOFITT CLASSIC W25 SAMPLING VALVE - HEADS

W25 HEADS

PTFE

TYPE N
LEVER HANDLE
PNEUMATIC









875544

TYPE B
NO SPRING
0-12 BAR

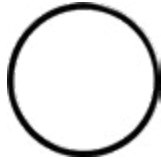

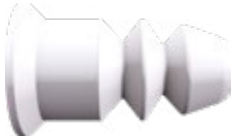
875547

KEOFITT CLASSIC W25 - PARTS & ACCESSORIES

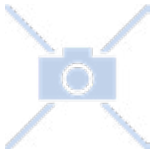
W25™ PARTS & ACCESSORIES	O-RINGS	 400208 EPDM 60X3	 900091 GASKET EPDM 1"	
	MEMBRANES	 870055 PTFE		
	FOR VALVE HEADS	 870255 TOOL PTFE		
	MISC.	 900086 CLAMP RING 1"	 800014 ADAPTER TC/1"	 900093 GASKET EPDM 3"

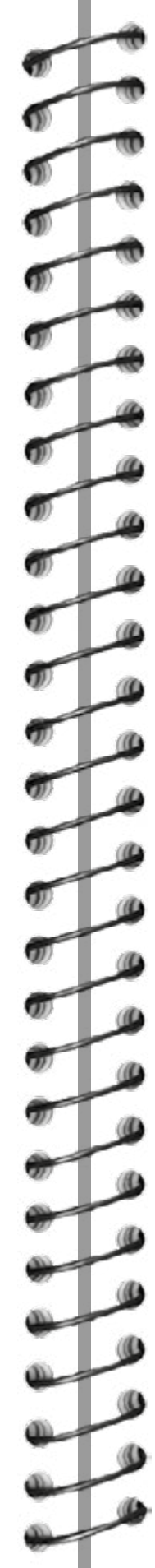

 900187 CLAMP RING"		